

SPEED / VOLTAGE

STRIKER



USER'S MANUAL

A

TRAILTECH

COMPUTER

Quick-start

Normal Mode



Backlight



Switch Screens



Stop Watch

Setup Mode



Enter Setup



Switch Screens



Scroll Value



Next Digit

Data Reset



Reset Ride Data

Adjust Trip Distance Mode

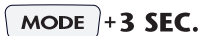

Enter / Exit



Scroll Value

A Note to You

Trail Tech brings functionality and life to your motor vehicle with high quality and innovation. To ensure long and trouble-free operation, this User's Manual contains valuable information about how to operate and maintain your digital gauge properly.

Please read this manual carefully.

STRIKER

If you call to request service for your Striker digital gauge, you need the date of purchase, dealer's name, address, and telephone number. Warranty service requires proof of purchase.

PURCHASE DATE _____

DEALER NAME _____

DEALER ADDRESS _____

DEALER PHONE _____

Keep this book and sales slip together for future reference.







Precautions

WARNING

- Read all instructions before using Striker.
- Avoid contact with gasoline, degreasers or other chemical cleaners.
- Striker can be used in the rain but should not be used underwater.
- Do not wash with pressure washer.
- When installing Striker, disconnect the vehicle battery.
- When installing radiator hose temperature sensors, make sure it fits BEFORE cutting the radiator hose.
- Do not leave the main unit in direct sunlight when not riding.
- Check gap between speed sensor and magnet periodically.
- Do not bend, twist, kink or abuse the sensor cables.
- To reduce the risk of injury, do not disassemble Striker or its accessories.

**PAY ATTENTION
TO THE TRAIL!**

Specifications

FUNCTION	ICON	UNITS	RANGE
Current Speed	SPD	KM/H or M/H	4 - 299.9
Average Speed	AVG SPD	KM/H or M/H	4 - 299.9
Maximum Speed	MAX SPD	KM/H or M/H	4 - 299.9
(Trip) Distance	DST	KM or M	0.00 - 299999
Odometer	ODO	KM or M	0.00 - 299999
Voltage	V	VAC/VDC	1.6-52.6
Minimum Voltage	MIN V	VAC/VDC	1.6-52.6
Maximum Voltage	MAX V	VAC/VDC	1.6-52.6
Hourmeter / Clock		H:M:S	12h or 24h
Ride Time	RT	H:M:S	0:0:0 - 9999:59
Stop Watch	TT	H:M:S	0:0:0 - 9999:59
Accum. Ride Time	ART	H:M:S	0:0:0 - 9999:59
Air Temperature	AIR	°C or °F	0 - 999°
Engine Temperature		°C or °F	0 - 999°
Max Engine Temp	MAX 	°C or °F	0 - 999°
Oil Reminder		KM/H or M/H	0.0 - 9999
Care Reminder		KM/H or M/H	0.0 - 9999
Low Battery		3V	~ 1 year life
Tire Size		mm	0 - 3999 mm

Specifications

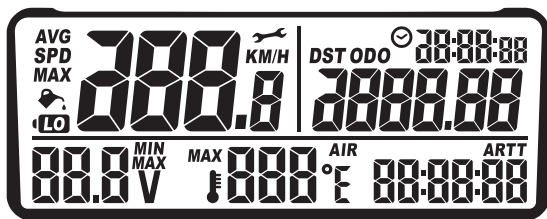

PHYSICAL FEATURE	DESCRIPTION
Speed/Distance Sensor	Non-contact Magnetic Sensor
Temperature Sensors	External Ambient and Engine Thermistor Sensors
Voltage Sensor	Red/Black Power Wire
Remote Thumb Switch	Optional, Mirrors Main Buttons
Backlight	5 White LED Group
Product Dimensions	106.93x59.46x23.7mm WxHxD (4.21x2.34x0.93")
Screen Dimensions	78.75 x 28.6mm (3.1 x 1.13")
Product Weight	3.9 oz. (110 grams) (0.24 lbs.)
Wheel Circumference	0 to 3999 mm
Operation Temperature	0°C to 60°C (32°F to 140°F)
Storage Temperature	-20°C to 80°C (-4°F to 176°F)
Battery	3V CR2032 (About 1 Year life)
External Power Input	9.0-400 VAC (No Polarity) 9.0-55.0 VDC (No Polarity)
Critical Environment	Amber/Red LED Alert System

Physical Features

Striker Computer:

Main Computer:

- The Striker computer has 3 buttons and 2 LED's.

LEDs:

- Amber Warning LED: Voltage [Flash], Temperature [Solid]
- Red Danger LED: Voltage [Flash], Temperature [Solid]

Remote Switch:

- Duplicates buttons on the main computer (sold separately.)

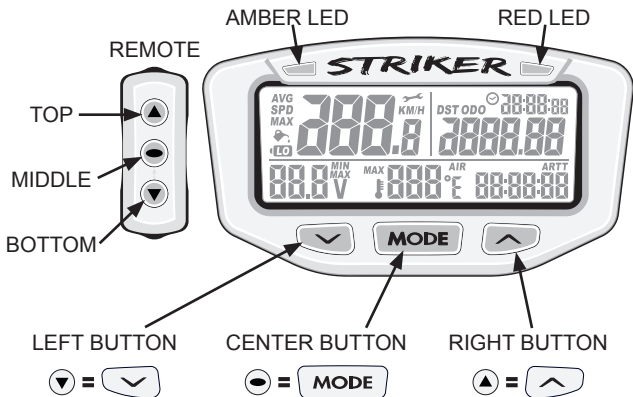

Physical Features

The Wires:

Temperature Sensor:

The temperature sensor is mounted in the radiator hose or cylinder head.

Remote Switch:

Connect the handlebar remote switch accessory (sold separately) to this connector. The remote switch mirrors the buttons on the main unit, for accessibility closer to the hand while riding.

Ambient Temperature Sensor

Power Cable:

The power wire connects anywhere in the vehicle's electrical circuit, or straight to the battery terminals.

Speed Sensor:

The speed sensor is mounted to the brake caliper on the wheel. Without the speed sensor mounted, Striker cannot display speed or gather distance data.

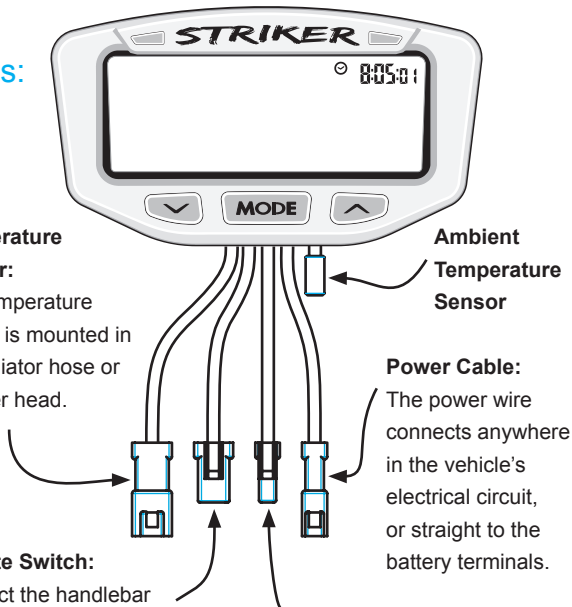

Physical Features

Reset Button:

Use of the reset button will erase data for the current ride including stop watch and trip distance. ODO and ART are permanent.

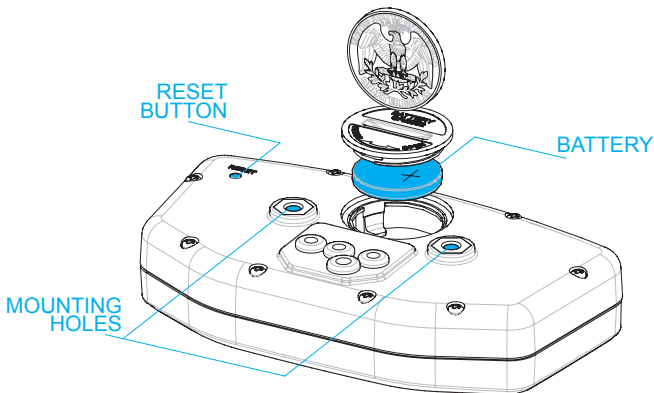

Internal Battery:

- Striker has an internal 3.0V watch type battery (#CR2032). The computer can be run from the internal battery without being connected to a vehicle power source. For proper, full-featured use (LEDs and voltage readouts), connect to vehicle power.
- To change the battery, unscrew the battery cap on the back of the computer with a coin. Make sure the positive side of the battery is facing up when replaced.
- REPLACE WITH BATTERY MODEL NUMBER #CR2032

Physical Features

Bar Mounting:

Place nuts and bolts as shown in picture.

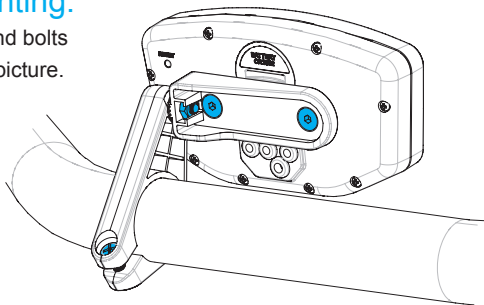

Temperature Sensors:

Please see-model-specific instructions for mounting procedure.

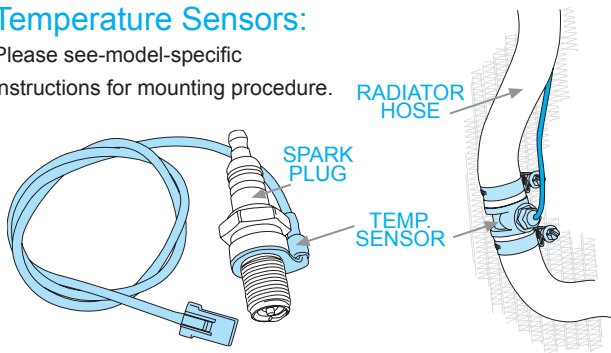

Cylinder Head Temperature
Sensor for air-cooled machines.

Temperature Sensor
in-line in radiator hose for
water-cooled machines.

Physical Features

DRILL TEMPLATE
SCALE 1:1

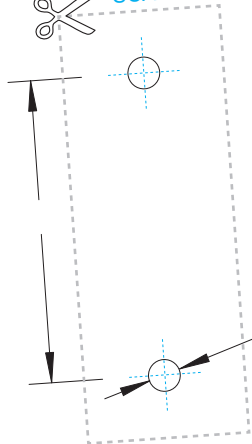

Drill Size:
• 4.2mm
• 0.165"

Flat/Surface Mount:

There are two screw holes on the back of Striker. Use the included M4 bolts to mount to any flat surface.

If other than provided screws are used, make sure they are not too long for mounting holes.

Screws that are too long will damage internal components of Striker.

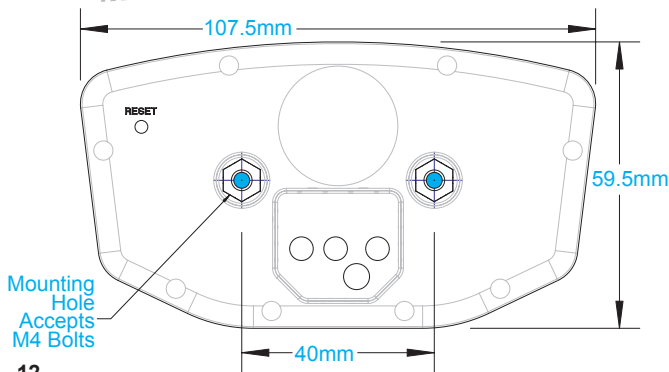

12 Volt Systems:

Connect to 12 volt system:

- The backlight will be 5x brighter.
- The temperature and voltage indicator LEDs will be enabled.
- The voltage readout will function.

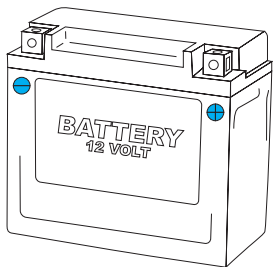

OPTION 1) BATTERY WIRED:

Connect the power cables directly to the vehicle's 12 volt battery.

OPTION 2) SYSTEM TAP:

As an alternative to running wires all the way to the battery, it is possible to tap into the electrical system. It is best to connect so power is not interrupted by the key switch.

- The “LO” indicator will activate if voltage drops below 2.45V.
- Striker draws too little power to drain the vehicle battery.
- Striker is polarity independent.

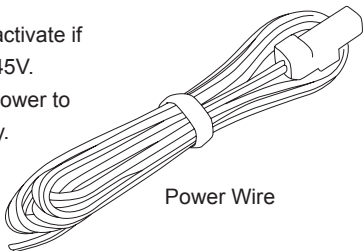

Power Wire

ATV Sensor/Magnet Installation:

Striker needs two things to be able to collect distance data:

1. A magnet placed on the spinning part of the wheel.
2. A speed sensor, placed on the stationary part of the wheel.

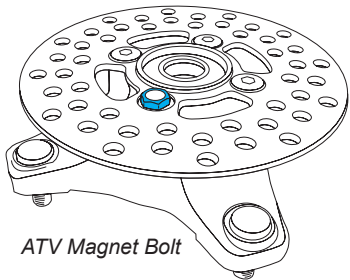

ATV Magnet Bolt

The magnet spins around tripping the sensor switch each time--giving Striker speed, distance and time data.

The magnet is installed on the brake rotor because it spins with the wheel. The provided magnetic bolt can simply replace a stock rotor bolt (see above picture). If that will not work, glue the spare magnet in a hole on the brake rotor. (JB Weld or a similar slow-cure epoxy works well.)

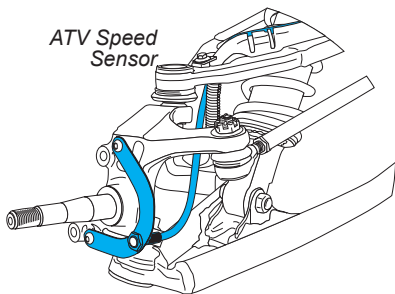

ATV Speed Sensor

After the magnet is in, the sensor is placed on a non-spinning part the wheel, rotor shield, or provided bracket.

Motorcycle Sensor/Magnet Installation:

Motorcycles, like ATVs, need a magnet placed on the spinning part of the wheel and the sensor installed to a non-spinning part.

The magnet typically gets bolted or glued to the brake rotor. The speed sensor wire should come from the back of the computer, be cable-tied to the brake line as it travels down the front forks, then attached to the brake caliper.

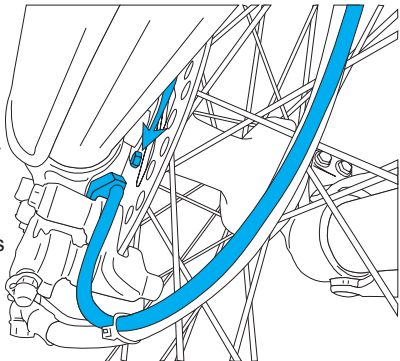

Magnet About to Pass Under Sensor

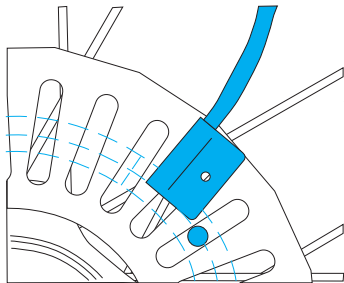

Optimum Magnet Rotation Path

Striker can tell how far and fast it's traveled by how many times the magnet passes the sensor.

Many Motorcycles and ATVs have special installation procedures. Refer to the provided installation insert for model-specific instructions.

Measure Wheel Size

Overview:

Knowing your exact wheel size is critical for Striker to calculate correct speed and distance data. The more accurate the wheel size, the better Striker performs.

Method 1: Ruler

Find the circumference of front wheel by measuring its diameter in millimeters. Multiply the Wheel Diameter by 3.14. The result is your wheel size.

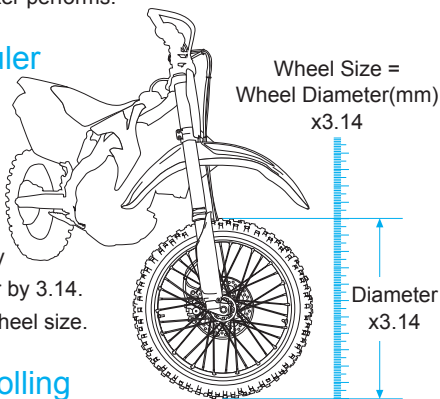

Method 2: Rolling

On a flat surface, mark the tire sidewall and the ground with a marking pen. Roll the wheel until the mark on the tire completes one revolution and is back on the ground. Mark the ground at this location. Measure the distance between the marks on the ground in millimeters (multiply inches by 25.4 to convert to mm). Use this number for your wheel size. For accuracy, the rider's weight should be on the bike when making the measurement.

Measure Wheel Size

Method 3: Distance Measurement

This is the most accurate method.

1. Set the wheel size to 2110mm (motorcycle) or 1675 (ATV).
2. Find a length of road where the distance is known.
3. Ride the distance, noting how far the computer reads (i.e. the road is known to be 5 miles and the computer shows 4.95 miles.)
4. Use the numbers to solve for X in the following equation:

$$(\text{new wheel size}) = \frac{(\text{actual miles}) \times (\text{current wheel size})}{(\text{current miles})}$$

$$X = \frac{5 \times 2110}{4.95}$$

$$X = \frac{10550}{4.95}$$

$$X = 2131$$

5. Enter the number found above into Striker.

--	--	--	--

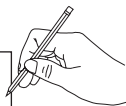

User Interface

Normal Mode:

All of the information that Striker provides is on one of these 3 screens. When riding, the user has the choice of staying on Screen 1 or Screen 2. Screen 3 contains statistical information and reverts back to screen 1 after a short period.

**TO SWITCH BETWEEN SCREENS,
PRESS THE CENTER BUTTON**



(or the middle button on the remote.)

Screen 1:

- **Speed** (pg.21)
- **Trip Distance** (pg.22)
- **Clock** (pg.26)
- **Voltage** (pg.24)
- **Engine Temp** (pg.25)
- **Ride Time** (pg.27)



Screen 2:

- **Speed** (pg.21)
- **Trip Distance** (pg.22)
- **Clock** (pg.26)
- **Voltage** (pg.24)
- **Air Temp** (pg.25)
- **Stop Watch (TT)** (pg.26)



Average speed may be set up to display on screen 2 rather than on screen 3 (pg.38).

Screen 3:

- **Avg Speed** (pg.21)
- **Max Speed** (pg.21)
- **Odometer** (pg.22)
- **Clock** (pg.26)
- **Accum. Ride Time** (pg.27)
- **Max Voltage** (pg.24)
- **Min Voltage** (pg.24)
- **Max Engine Temp** (pg.25)

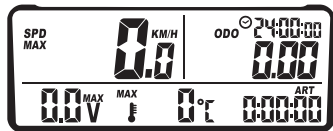

Striker alternately displays min/max voltage and avg/max speed every 2 seconds.

System Features

Overview:

System Modes:

- “Normal Mode” is displayed during regular use. (pg.18-19)
- “Sleep Mode” displays only the clock after inactivity. (pg.20)
- “Setup Mode” edits system options. (pg.31-38)
- “Trip Distance Edit Mode” edits the distance (DST) value. (pg.23)
- “Trip Data Reset” resets temporary values to 0. (pg.30)

Available Data:

- Speedometer (Speed, Average Speed, Maximum Speed)
- Voltage (Voltage, Maximum Voltage, Minimum Voltage)
- Distance (Odometer, Adjustable Trip Distance)
- Clock (Time of Day, Ride Time, Stop Watch, Accumulated Ride Time)
- Temperature (Ambient Air and Engine)

Sleep Mode:

If Striker sees no activity (either wheel movement or a button press) for 5 minutes, it will enter sleep mode and only display the clock. Sleep mode will end when any activity is noticed.



System Features

Speedometer:

Description: The speedometer function provides a display of current, average and max speed. Vehicle speed is calculated from the wheel sensor and user-entered wheel circumference.

Speed: Displayed on screen 1 accompanied by a lit SPD icon.

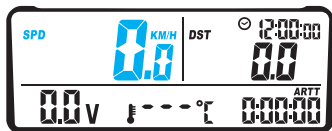

SPD on Screen 1

Average Speed: Displayed on screen 3 with a lit AVG SPD icon. AVG SPD is reset during a trip data reset.

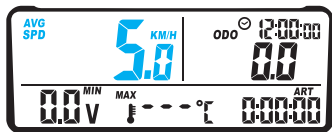

AVG SPD on Screen 3

Maximum Speed: Displayed on screen 3 with a lit MAX SPD icon. Max speed is reset during a trip data reset.

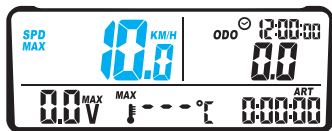

MAX SPD on Screen 3

By default, Striker alternately displays avg speed and max speed every 2 seconds on screen 3. Average speed can move to screen 2 using setup mode. If done, average speed will move to screen 2 and replace the current speed. (pg.38)

System Features

Distance:

Description: The distance function provides a display of current trip distance and a permanent odometer. Distance is calculated from the wheel sensor and user-entered wheel size. (pg.16)

Trip Distance: Displayed on screens 1 and 2 in the upper right with a lit DST icon. DST is reset during a trip data reset.

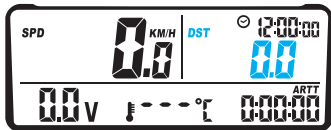

DST on Screen 1

Odometer: Displayed on screen 3 in the upper left with a lit ODO icon. ODO is NOT resettable. *ODO has a resolution of 0.1 from 0-2999, then shifts to a resolution of 1 from 3000-299,999.*

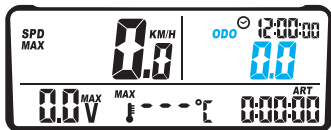

ODO on Screen 3

PERFORM A TRIP DATA RESET BY HOLDING THE LEFT AND CENTER BUTTONS FOR 3 SECONDS. (pg.30)

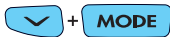

Striker can display tenths (0.0) or hundredths (0.00) decimal places for distance and odometer. (pg.38)

Trip Distance Edit Mode:

Description: The trip distance meter shows how much distance has been traveled since the last reset. Trip distance can be incremented manually using trip distance edit mode. Modifying trip distance is useful for synchronizing computers in the field for use in racing and technical comparisons.

Adjust Trip Distance: When in trip distance edit mode, Striker displays only trip distance and the DST icon. Use the buttons to modify the DST value.

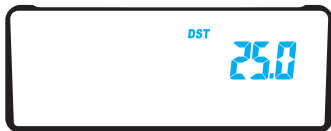

ENTER OR EXIT TRIP DISTANCE EDIT MODE BY HOLDING THE CENTER BUTTON FOR 3 SECONDS.



SCROLL DISTANCE VALUE BY PRESSING THE RIGHT OR LEFT BUTTONS. Hold to scroll faster.



Striker will return to normal mode after 5 seconds of inactivity.

Striker can display tenths (0.0) or hundredths (0.00) decimal places during trip distance edit mode. (pg.38)

System Features

Voltage:

Description: The voltage function provides a display of voltage, maximum voltage, and minimum voltage. Voltage data is measured from the power input wire. It has a resolution of 0.1 volts and is accurate across the entire sensor range.

Voltage: Displayed on screens 1 and 2 in the lower left with a lit V icon. Displays 0.0V if not connected to vehicle power. Displays HI if voltages exceeds the maximum specification (52.6V.)

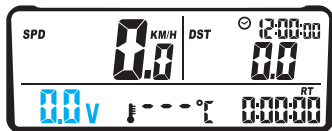

Voltage on Screen 1

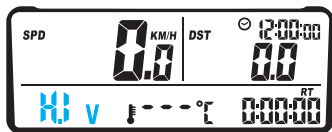

Exceeding 52.6 Volts

Max/Min Voltage: Displayed on screen 3 in the lower left. Min/Max voltage alternates being displayed every second, accompanied by V and the respective MIN/MAX icon.

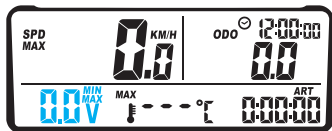

Min/Max Voltage on Screen 3

Voltage LEDs: The LEDs will flash if the voltage falls below the values defined by the user in setup mode, alerting of potential electrical system problems. See data setup mode for more information. (pg.36)

System Features

Temperature:

Description: The temperature function includes engine temperature, ambient temperature, and maximum engine temperature. The LEDs can alert of over-temp issues.

Engine Temperature:

Displayed on screen 1 in the lower middle with a thermometer icon.

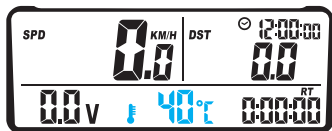

Engine Temperature on Screen 1

Ambient Temperature:

Displayed on screen 2 with the AIR icon.



Ambient Temperature on Screen 2

Max Engine Temperature:

Displayed on screen 3 with the MAX icon.

Temperature LEDs: The LEDs will turn on solid if the temperature exceeds the values defined by the user in setup mode, alerting of potential over-temp motor issues. (pg.35)

System Features

Time:

Description: The time features consist of a clock, current ride timer, accumulated run time, and stop watch (TT.)

Clock: Displayed in the upper right on all screens, the clock increments continuously and has a selectable 12H or 24H H:M:S display.

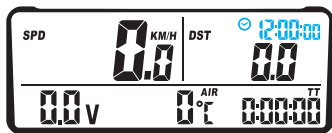

Time-of-Day Clock on All Screens

Stop Watch (TT): Displayed on screen 2 in the lower right corner. The clock icon flashes while the stop watch is running. The stop watch is reset during a trip data reset.

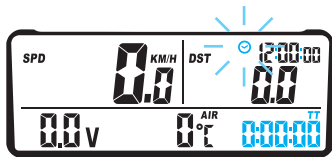

Stop Watch on Screen 2

START OR PAUSE THE STOP WATCH BY PRESSING THE LEFT BUTTON ON ANY SCREEN.



TO RESET THE STOP WATCH, PERFORM A TRIP DATA RESET BY HOLDING THE LEFT AND CENTER BUTTONS FOR 3 SECONDS. (pg.30)

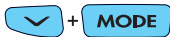

System Features

Ride Time: Displayed in the bottom right corner of screen

1. Ride time shows how long the bike has been rolling since the last trip data reset. Ride time only increments when the vehicle is in motion.

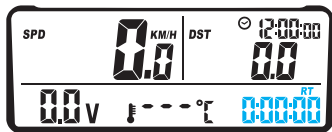

Ride Time on Screen 1

TO RESET THE RIDE TIME, PERFORM A TRIP DATA RESET BY HOLDING THE LEFT AND CENTER BUTTONS. (pg.30)

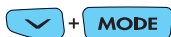

Accumulated Ride Time:

Similar to the odometer, accumulated ride time (ART) is not user resettable. Displayed in the bottom right corner of screen 3. ART tracks the total amount of time the vehicle has been in motion.

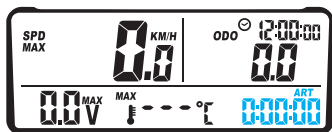

Accumulated Ride Time on Screen 3

After 99 hours, ART rolls from H:M:S display to H:M up to 9999 hours. ART does not roll over to 0 when the max value is reached.

Maintenance Icons:

Description: There are two maintenance icons: OIL CAN and WRENCH. They alert of upcoming maintenance intervals. There is also a LO-BATTERY indicator to alert of low internal battery life.

Maintenance Icons: Set a value in setup mode for each icon. Striker will countdown the miles, then display the icon. (pg.37)



Wrench, Oil and Lo Battery Icons

Lo Battery: The Lo-Battery icon is activated when the internal battery needs to be replaced. (Below 2.45V.)

Things that will NOT reset the maintenance reminders:

1. Entering data setup mode.
2. Using the adjustable trip distance feature.
3. Resetting single-ride data.
4. Pressing the reset button on the back of Striker.

When maintenance reminder setting screens are viewed in data setup mode, the icons will clear if they have been activated. (pg.37)

System Features

Backlight:

Description: Striker is equipped with a quality LED backlight for night-time operation.

Connected to Vehicle Power:

The backlight will turn off and Striker will enter sleep mode after 5 minutes of inactivity (any button press or wheel movement.)

Internal Battery Only:

The backlight must be activated by pressing the RIGHT button, will only remain lit for 3 seconds, and will light dimly to conserve internal battery power. If the LO-BATTERY icon is lit, the backlight will not turn on. Sleep mode will be entered after 5 minutes of inactivity.



**TO ACTIVATE THE BACKLIGHT
MANUALLY, PRESS**



Data Reset

Data Reset:

Description: After every ride, a trip data reset should be performed. The data will be reset to zero so that new information can be logged on the next ride.

Values reset during a Data Reset:

- **Avg Speed** (pg.21)
- **Max Speed** (pg.21)
- **Trip Distance** (pg.22)
- **Stop Watch (TT)** (pg.26)
- **Ride Time** (pg.27)
- **Max Voltage** (pg.24)
- **Min Voltage** (pg.24)
- **Max Engine Temp** (pg.25)

PERFORM A TRIP DATA RESET BY HOLDING THE LEFT AND CENTER BUTTONS FOR 3 SECONDS.

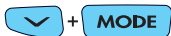

Notes:

- The reset can be done from any screen.
- Accumulated Ride Time (ART) and Odometer (ODO) cannot be reset and are intended to maintain cumulative information.

Setup Mode

Overview:

Description: Setup mode is crucial for Striker to operate correctly.

SETTINGS ORDER	VALUE	DEFAULT
A. Distance Units	KM/H or M/H	M/H
B. Tire Size	Millimeters	2109mm
C. Clock	12Hr or 24Hr Time-of-Day	12Hr 12:00:00
D. Temperature	°F or °C	°F
E. LED Alerts	Temperature High Alert Temperature Danger Alert Voltage Low Alert Voltage Danger Alert	000° 000° 0V 0V
F. Maintenance	Oil Countdown Care Countdown	0000 M/H 0000 M/H
G. AVG SPD	Screen 2 or 3	Screen 3
H. Distance	Resolution	Res 2

Enter Setup Mode:

**HOLD DOWN ALL THREE
BUTTONS FOR 3 SECONDS.**



All segments on the screen will turn black. Release to continue.



Setup Mode

Setup Distance Units:

Striker defaults to M/H.

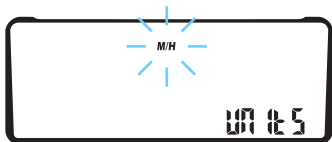

**TO CYCLE BETWEEN M/H AND KM/H,
PRESS THE LEFT BUTTON.**



TO CONFIRM, PRESS THE CENTER BUTTON.
Striker will move on to the next setting.



Setup Wheel Size:

See “Measure Wheel Size” on page 16 for more information.

DEFAULT ATV: 1675mm
MOTORCYCLE: 2110mm



MODIFY DIGIT: LEFT BUTTON
NEXT DIGIT: RIGHT BUTTON



TO CONFIRM, PRESS THE CENTER BUTTON.
Striker will move on to the next setting.



Setup Mode

Setup Clock Format:

Striker defaults to 12 Hr format.



**TO CYCLE BETWEEN A 12 HR OR 24 HR
CLOCK, PRESS THE LEFT BUTTON.**



TO CONFIRM, PRESS THE CENTER BUTTON.

Striker will move on to the next setting.



Setup Time of Day:

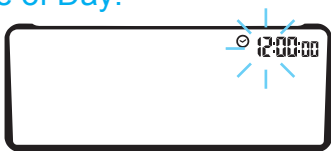

MODIFY DIGIT: LEFT BUTTON

NEXT DIGIT: RIGHT BUTTON

TO CONFIRM, PRESS THE CENTER BUTTON.

Striker will move on to the next setting.



Setup Temperature Units:

Striker defaults to fahrenheit.



TO CYCLE BETWEEN °F and °C, PRESS THE LEFT BUTTON.



TO CONFIRM, PRESS THE CENTER BUTTON.

Striker will move on to the next setting.



The next two sections detail the over-temperature and under-voltage alert LEDs. The temperature alert will light up the LEDs solid-on, while the voltage alerts cause the LEDs to flash.

Because a high engine temperature alert is a serious issue, it will override the voltage alert, should they happen to activate simultaneously.

Striker must connect to vehicle power for LEDs to function.

Setup Mode

Setup High Temperature LED:

If engine temperature reaches this setting, the yellow LED will turn on as a caution.

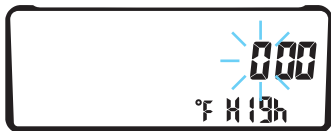

0° (default) disables this alert.

MODIFY DIGIT: LEFT BUTTON



NEXT DIGIT: RIGHT BUTTON

TO CONFIRM, PRESS THE CENTER BUTTON.



Striker will move on to the next setting.

Setup Danger Temperature LED:

If engine temperature reaches this setting, the red LED will turn on as a critical warning.



0° (default) disables this alert.

MODIFY DIGIT: LEFT BUTTON



NEXT DIGIT: RIGHT BUTTON

TO CONFIRM, PRESS THE CENTER BUTTON.



Striker will move on to the next setting.

Setup Mode

Setup Low Voltage LED:

If voltage falls below this setting, the yellow LED will flash on as a caution.



0V (default) disables this alert.

MODIFY DIGIT: LEFT BUTTON



NEXT DIGIT: RIGHT BUTTON

TO CONFIRM, PRESS THE CENTER BUTTON.



Striker will move on to the next setting.

Setup Danger Voltage LED:

If voltage falls below this setting, the red LED will flash as a critical warning.



0V (default) disables this alert.

MODIFY DIGIT: LEFT BUTTON



NEXT DIGIT: RIGHT BUTTON

TO CONFIRM, PRESS THE CENTER BUTTON.



Striker will move on to the next setting.

Setup Mode

Setup Oil and Wrench Alerts:

Set the number of kilometers or miles left until Striker displays the oil and wrench reminder icons. After setting <OIL>, the <CARE> setting will appear. 0 KM/H or M/H (default) disables these alerts.

- Each km/mile travelled lowers the reminder values by 1.
- When the countdown reaches 0, the respective icon will activate.
- Striker will not reset these values automatically; they must be manually increased in setup mode.
- When these screens are viewed in setup mode, the icons will clear if they have been activated by reaching their countdowns.

NOT affected by:

- Entering setup mode.
- Using the adjustable trip distance feature.
- Resetting single-ride data.
- A system reset.

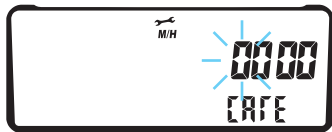

MODIFY DIGIT: LEFT BUTTON
NEXT DIGIT: RIGHT BUTTON
TO CONFIRM, PRESS THE CENTER BUTTON.



Striker will move on to the next setting.



Setup Mode

Setup Average Speed's Screen:

Choose screen for AVG SPD (default 3.) If screen 3, then AVG SPD and MAX SPD rotate every 2 seconds. If screen 2, AVG SPD replaces SPD.



MODIFY DIGIT: LEFT BUTTON
NEXT DIGIT: RIGHT BUTTON



TO CONFIRM, PRESS THE CENTER BUTTON.



Striker will move on to the next setting.



Setup Distance Resolution:

Choose if Striker should display one (0.0) or two (0.00) decimal places for distance and odometer.



TO CYCLE BETWEEN ONE (0.0) and TWO (0.00) DECIMALS, PRESS LEFT BUTTON.



TO CONFIRM, PRESS THE CENTER BUTTON.



Striker will return to normal mode.



Notes

Notes: _____

FAQ Troubleshooting

Frequently Asked Questions:

Why does nothing work?

- Try the reset button on the back of Striker.
- The internal battery may be dead, or Striker is not hooked up to vehicle power properly. Review installation procedure.

What kind of electrical systems does Striker work with?

- The voltage readout works on systems with any type of battery (lead acid, NiMH, NiCad, Li-Ion, etc.)
- Striker works best on vehicles with DC electrical systems (where a battery or capacitor is installed.) The voltage readout will be accurate and comparable to quality multi-meters.
- Striker will operate on AC electrical systems but displays voltage with less accuracy. (Not a true RMS meter.)
- Striker operates with a 4-point floating voltage average.

Everything is working, but the (K)MPH reading is way off.

- The speed sensor/magnet may be installed incorrectly. Double check installation. See page 14-15.
- The wheel size setting may be incorrect. Please review wheel size measurement instructions in this manual. See page 16.

FAQ Troubleshooting

The screen is hazy or crazed.

- Did gasoline, degreasers, or other chemical cleaners come in contact with Striker's screen? Chemicals can damage Striker.

The backlight won't stay lit.

- Striker needs to be connected to vehicle's 12 volt system in order for the backlight to be continuous on. Review installation procedure. See page 9 and 29.

Striker's internal battery is dead.

- To replace the battery, use a coin to unscrew the round panel on the back of Striker. Remove the old battery and install the new one. Make sure the positive pole is facing up. Replace with common watch battery CR2302. See page 10.

Why aren't the LEDs working?

- **Striker needs to be connected to the vehicle battery in order for the LEDs to function.**
- Settings must be programmed manually. See pages 35-36.
- The LEDs dim or go out if the vehicle battery voltage is too low.

The maintenance icons won't clear off the screen.

- Go into setup mode and make sure OIL and CARE are both set to 0. The icons should then disappear from the normal screens. See page 37.

Glossary

ACCUMULATED RIDE TIME (ART): The long-term total amount of time spent riding (all ride times added together.) ART cannot be reset.

ADJUSTABLE DISTANCE EDIT: Special mode to edit the distance traveled since the last data reset. Page 23.

AVERAGE SPEED (AVG SPD): The mean (average) speed the vehicle has been traveling since the last data reset.

BACKLIGHT: The light that brightens up Striker's display.

(TRIP) DISTANCE (DST): The distance covered since the last data reset.

LEDs: The LEDs at the top of Striker can be programmed to alert of problems with voltage or temperature.

MAINTENANCE REMINDERS (🔧🔧): The user programmable countdown in miles or kilometers for oil and wrench reminder icons.

MAXIMUM SPEED (MAX SPD): The fastest speed achieved since the last data reset.

ODOMETER (ODO): The total accumulated distance Striker has traveled. The odometer is permanent and cannot be reset.

REMOTE SWITCH: Optional remote control that mounts to handlebar next to the hand. The remote's buttons duplicate the buttons on the main computer, but make them easier to reach.

RIDE TIME (RT): The amount of time the wheels have been rolling since the last data reset.

SENSORS: The speed sensor works with the magnet to let Striker collect its wheel data; a second sensor measures the temperature.

SLEEP MODE: If Striker doesn't receive any sensory information it will go into Sleep Mode and only display the clock.

SPEED (SPD): The vehicle's current speed.

STOP WATCH (TT): This is a short term, regular stop watch.

VOLTAGE (V): The condition of the vehicle's battery and electrical system.

WHEEL SIZE: Very important. Used to determine speed and distance. Refer to the measurement section. Page 16-17.

LIMITED WARRANTY

Within one year from the date of original purchase, Trail Tech will repair or replace, at its option, any Trail Tech powersport computer which is deemed defective in workmanship or materials.

Please contact Trail Tech or the dealer where the item was purchased for assistance.

Damage or injuries resulting from negligence or misuse are not covered by this warranty. Incidental or consequential damages are specifically excluded.* This warranty gives you specific legal rights. You may also have other rights which vary from state to state.

**Because some states do not allow the exclusion of incidental or consequential damages, this exclusion may not apply to you.*

MADE IN AMERICA

TRAIL TECH

Trail Tech and Striker are trademarks of Trail Tech, Inc.

www.trailtech.net
360-687-4530

